



欧创
EUPRUN MEDICAL

杭州欧创医疗器械有限公司
HANGZHOU EUPRUN MEDICAL INSTRUMENT CO.,LTD.



欧创
EUPRUN MEDICAL

先进的技术，可靠的工艺，稳定的质量，周到的服务
Advanced Technology, Reliable Craftsmanship, Steady Quality, Good Service



内窥镜系列手术器械

杭州欧创医疗器械有限公司
HANGZHOU EUPRUN MEDICAL INSTRUMENT CO.,LTD.

地址：浙江杭州桐庐县城环城南路939号
电话：0571-64363222
传真：0571-64271222



CE 0197

产品目录2013年第1版



欧创

EUPRUN MEDICAL

发展观

Development Concept

做精 做强 做长

To be professional, strong and long-lasting



厂区



精工车间



办公区

企业简介

杭州欧创医疗器械有限公司坐落于风景秀丽的富春江畔-桐庐，生产厂房占地 12000平方米，是集医用内窥镜配套手术器械和设备的研发、生产和销售于一体的新型高新技术企业，企业已通过ISO9001和13485质量体系认证。

公司致力于品牌营销，坚持走专业化、产业化、规模化的道路，整合产业优势，目前在行业内和客户中具有良好的信誉度和知名度，是微创手术器械行业中的佼佼者。

公司管理团队80%具有大专以上学历，90%以上一线工人经过了专业培训并在实际操作中不断得到强化和提升，目前已经形成了一支专业的管理、研发、生产、销售和优良的售后服务队伍。

欧创医械本着“同心协力、越做越好”的企业精神，“质量即生命、用户即家人”的企业宗旨，以雄厚的生产实力，良好的品牌形象和稳健的管理机制为客户提供更完善、更优质、更高效的服务，达到“只为人类健康”的企业使命。

Company Profile

Hangzhou Ouchuang Medical Instrument Co., Ltd. is located in the beautiful Fuchun River-Tonglu. The factory covers an area of 12000 square meters. And it is a new and national high-tech enterprise integrated research, development and marketing of medical endoscopic surgical instruments. The company has obtained the certification of ISO9001 and ISO13485 Medical Device Quality Management System.

The company is committed to brand marketing, and adheres to the road of specialization, industrialization and large-scale and conforms industry superiority. Currently, the company has a good reputation and visibility in the same field and among the customers. Meanwhile, the company is the best of the best in the field of minimally invasive surgical instruments.

In the management team, 80% members hold college diploma or above. And 90% front-line workers or more had received professional training. Additionally, their abilities had been strengthened and improved in the actual operation. At present, the company had formed a team with professional management, research, development and marketing and excellent after-sale service.

The company bases on the enterprise spirit of "work together, be better" and follows the tenet "Quality is life, the users are families". Besides, the company who depends on its strong production capacity, good brand image and steady management mechanism will provide more perfect, excellent and effective service for customers and finally achieves its mission "Only for people's health".

目录 Contents

胸腹腔镜、妇产科手术器械

Laparoscopic and Gynaecology Instruments	
腹腔镜窥镜及手术器械	第1-14页
OC-106 悬吊式提拉器	第14页
腹腔镜甲状腺手术器械	第15页
OC-102 腹腔镜结、直肠手术器械	第16页
OC-104 微型腹腔镜手术器械	第16页
OC-103 单孔腹腔镜手术器械	第17页
可弯手术器械	第18页
简易举宫器	第18页
多功能举宫器	第18页
特种举宫器	第19页
OC-302 新式非脱垂子宫经阴道切除手术器械	第20页
OC-303 型妇产科手术器械包	第20页
OC-301 电子宫切除器	第21-22页
OC-301B 电子宫切除器 (简配)	第23页
一次性使用医疗器械	第24页
器械消毒盒	第24页
腹腔镜电气、电子设备	第25页
GQ-IV 型宫腔镜	第26页
GQ-V 型宫腔镜	第26页
GQ-V A型宫腔镜	第26页
GQ-V B型宫腔镜	第26页
SL-III 型宫腔镜检查镜	第26页
GQ-II 型循环式宫腔镜检查镜	第26页
DGH-II 型宫腔电切镜 (宫腔手术用)	第27页

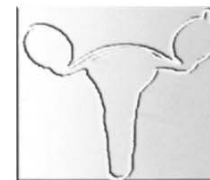

泌尿科

Urological department	
PG-V A型尿道膀胱镜	第27页
PG-V C型侧视尿道膀胱镜 (弹道碎石镜)	第28页
PGH-III 型膀胱电切镜 (汽化)	第28页
NG-II 型尿道切开镜	第28页
DS-II 型膀胱碎石镜 (大力碎石)	第29页
DS-II 型膀胱碎石镜 (咬式碎石)	第29页
DS-II 型膀胱碎石镜 (拉式碎石)	第29页
SN-I 型输尿管肾镜	第29页
SN-III 型输尿管肾镜 (经皮肾镜)	第29页

食道、肛肠科

Esophagus & Intestine department	
ST-II 型食道镜 (光纤导光)	第29页
YS-I 型乙状直肠镜 (光纤导光)	第30页

耳鼻喉科

E.N.T Department	
耳用显微手术器械	第30页
耳用手术电钻	第30页
YSB型剥离器 (鼻窦手术用)	第30页
XQG-II 型支气管镜	第30页
BD-III A型鼻窦镜	第31页
喉镜	第31页
ZH-III 型喉镜 (显微支撑)	第31页
耳镜	第32页

脑室镜系统

Ventriculoscope system	
VE-II A型脑室镜 (侧视式)	第32页
VE-II B型脑室镜 (侧视式)	第32页
VE-II C型脑室镜 (直视式)	第32页

骨科

Orthopaedics	
GJ-V 型关节镜	第32页
椎间盘镜手术器械	第32页

腹腔镜 Laparoscope

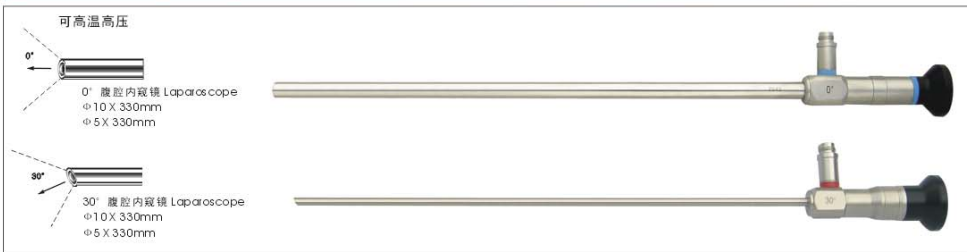

穿刺器 Trocar 密封帽 Sealing Cap



转换器 Reducer

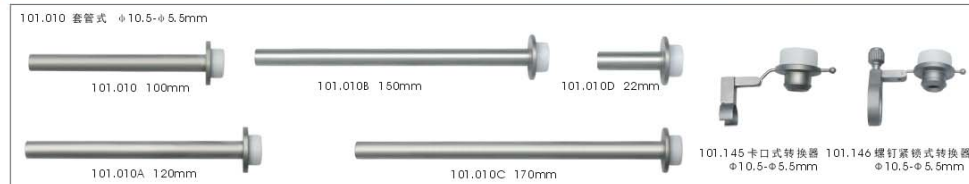

气腹针 Veress Needle



穿刺针 Needle



切开刀 Bile duct Knife

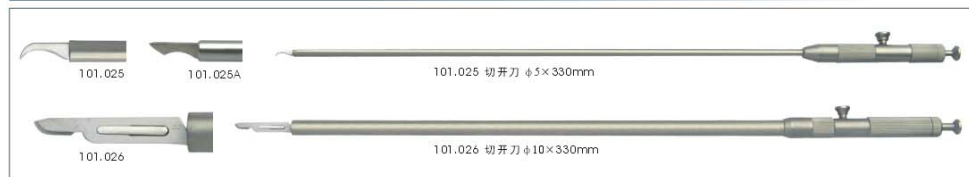

电凝 Monopolar HF Electrode



带电凝吸引器 Monopolar HF Electrode with S&I



单极电凝线 Cord for Monopolar



可拆换吸引器 Suction & Irrigation

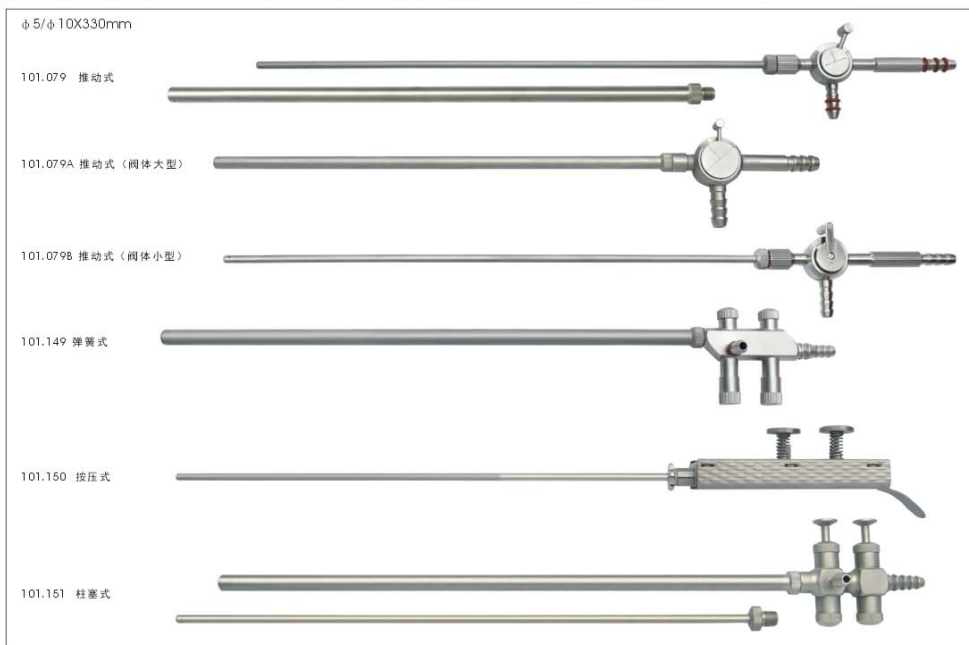

双极电凝钳 Bipolar 双极线 Cord for Bipolar

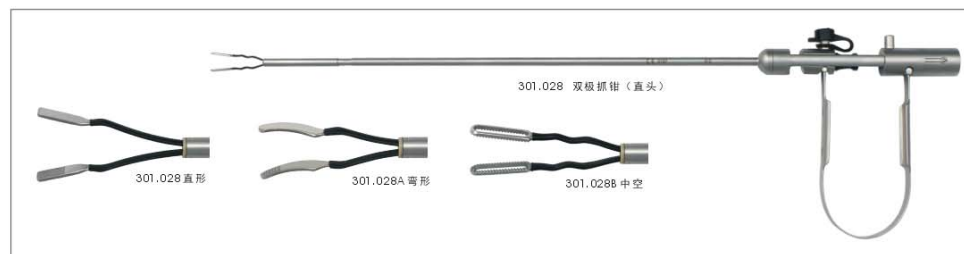

施夹器、结扎钉 Clip Applier, Polymer Ligation Clip,



松夹钳 Clip Remover



施夹器 (开放式) Open Clip Applier



钛夹、钛夹钳 Titanium Clip, Clip Applier

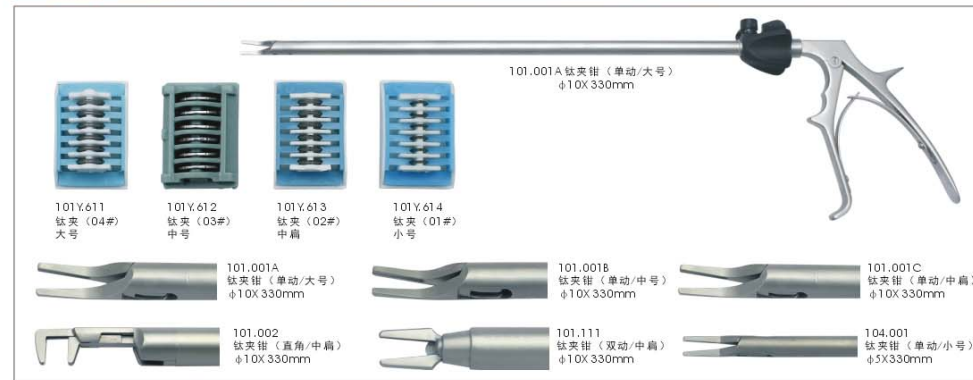

施夹器 Clip Applier



荷包抓钳 Purse Stitching Clamp



哈巴狗抓钳 Artery/Vein Clip, Clip Applier



持针钳 Needle Holder

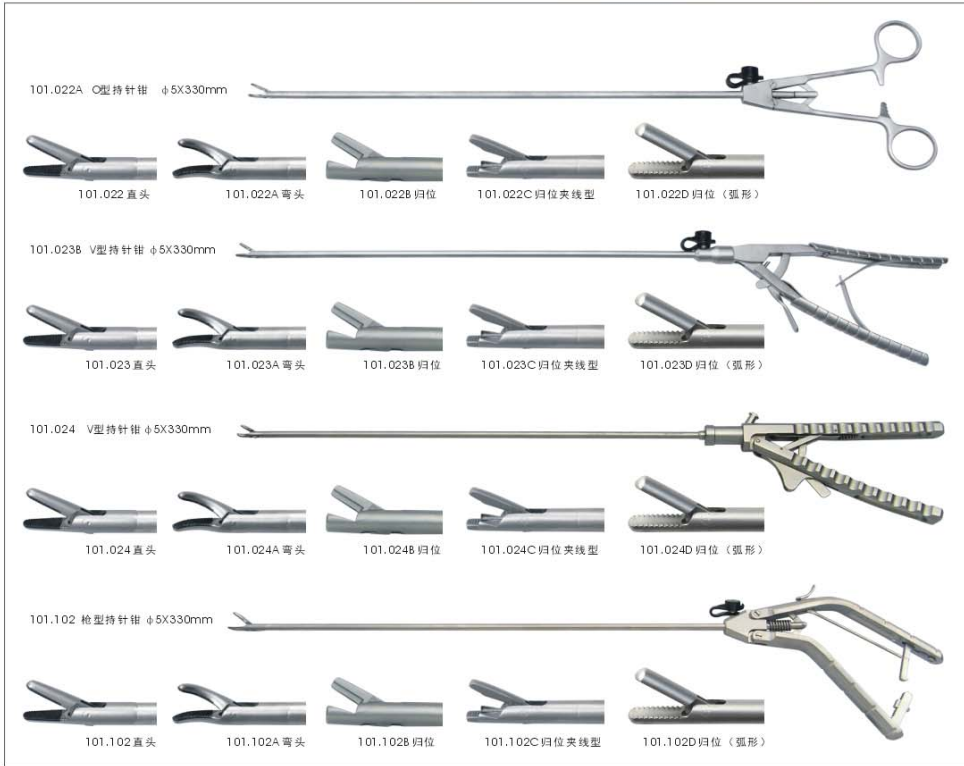

腹壁缝合钳 Closure Forceps

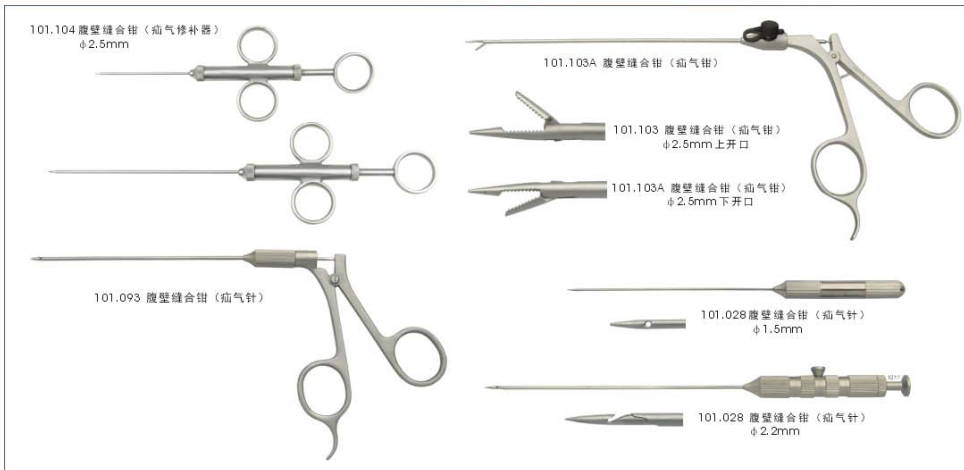

推结器 Knot Pusher

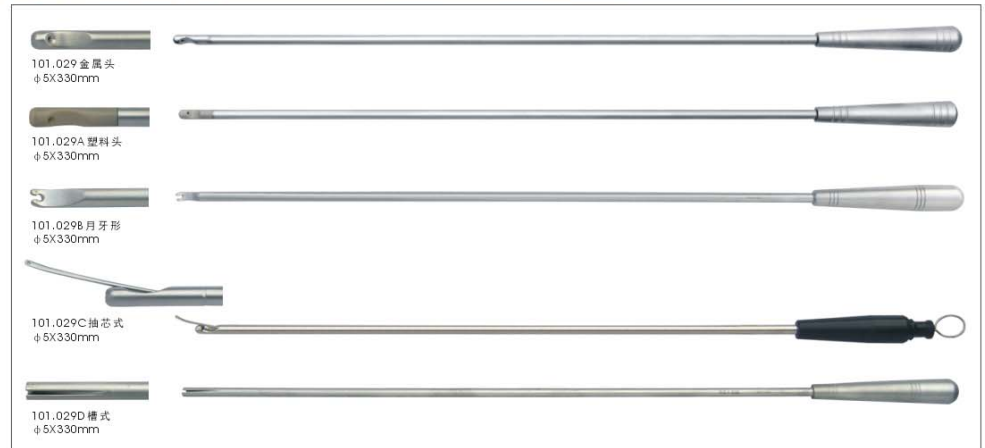

三叶钳、五叶钳 Retractor



撑开抓钳 (三叶) Retractor



5mm手术钳、剪 (Φ5X330mm) Forceps, Scissors



手柄 (Φ5mm) Handle



101F.001 塑料手柄



塑料手柄 (三折)



101F.003 金属手柄



101F.003A 金属手柄 (自锁式)

5mm手术钳、剪 (Φ5X330mm) Forceps, Scissors



手柄 (Φ5mm) Handle



101F.002 塑料手柄 (带锁卡)



塑料手柄 (三折、带锁卡)



101F.003 金属手柄 (中带卡)



101F.004 金属手柄 (下带卡)

10mm手术手术钳、剪 (Φ10X330mm) Forceps, Scissors

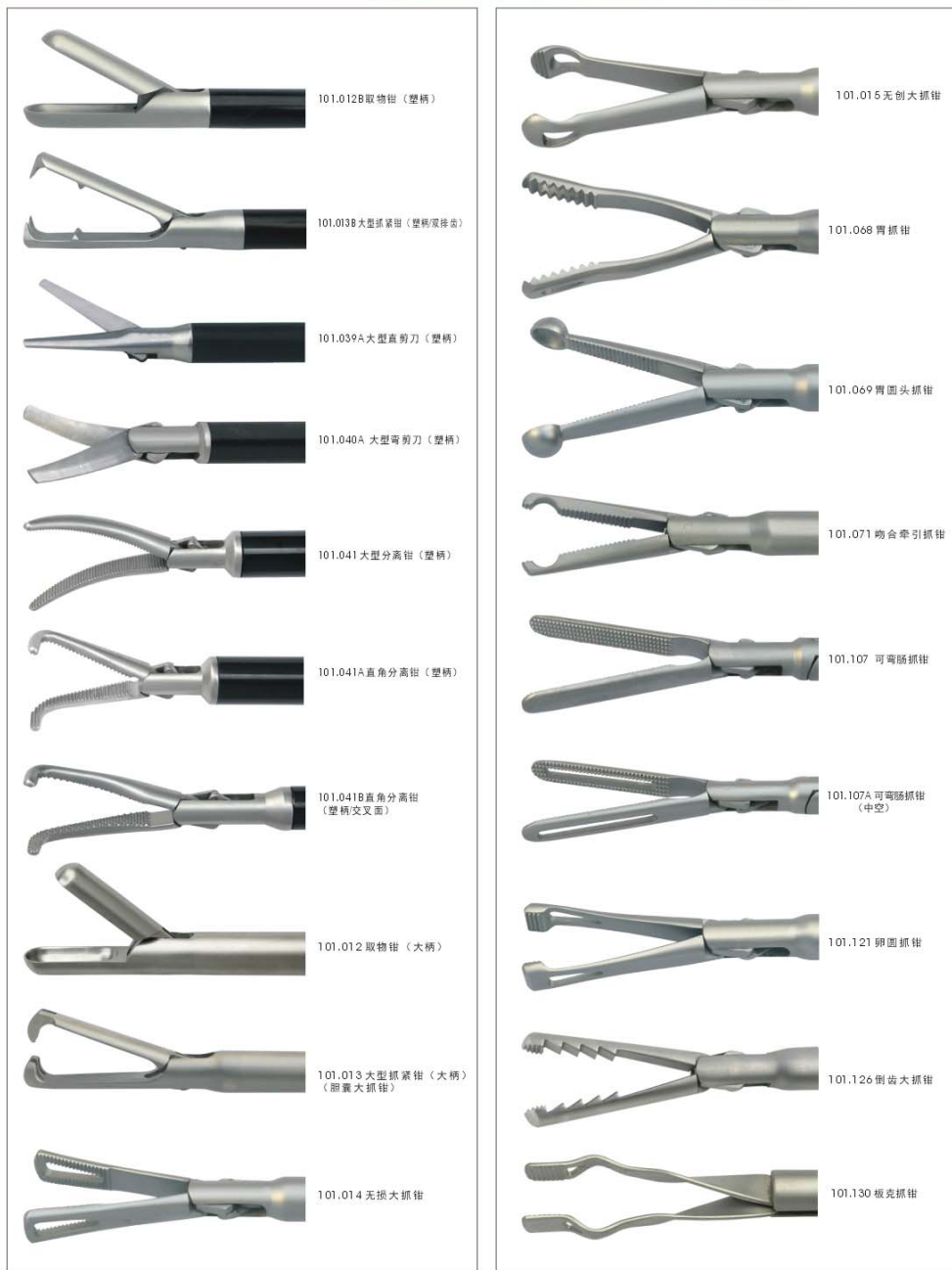

10mm手术手术钳、剪 (Φ10X330mm) Forceps, Scissors

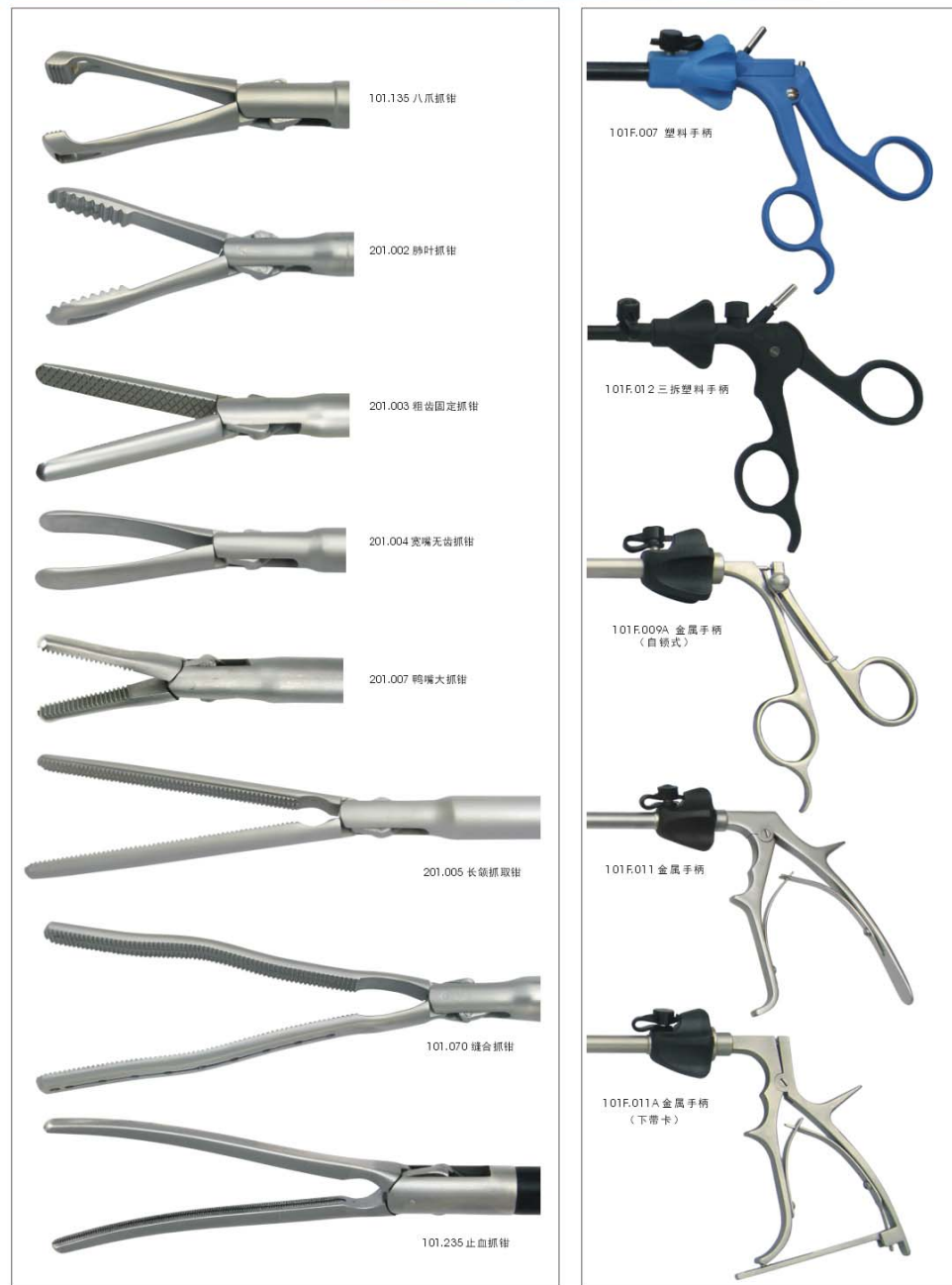

金手指抓钳 Golden Finger



肝脏拉钩 Liver Retractor 肾动脉拉钩 Retractor



可弯取物钳 Esophagus Retractor



动脉拉钩抓钳 Vein/Nerve Retractor



弹簧抓钳 Spring Grasping Forcep



胆道取石钳 Biliary Tract-Lithotomy Forcep



造影抓钳 Cholangiography Forceps



OC-106 悬吊式提拉器

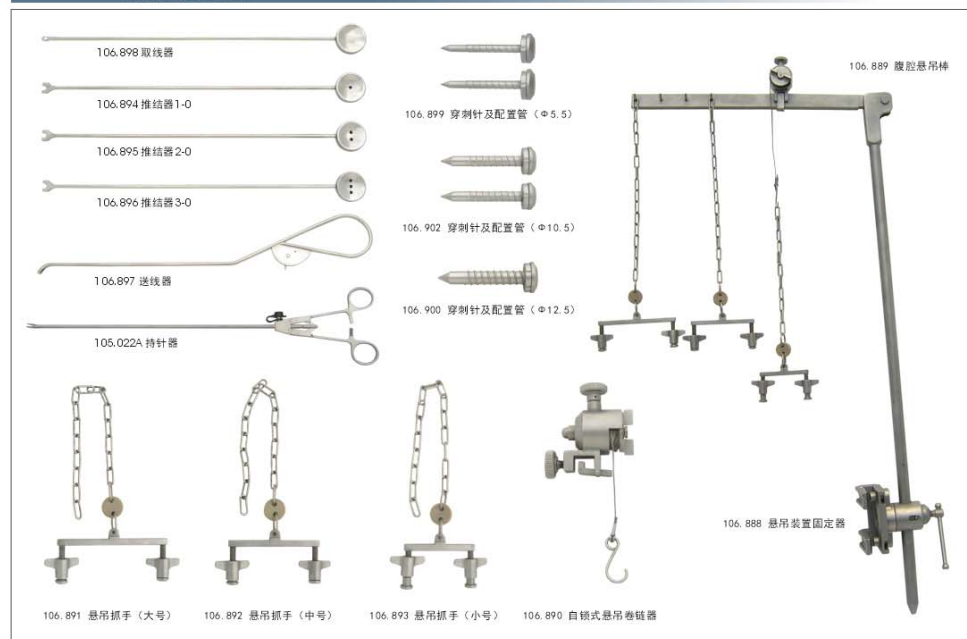

手术钳拆卸图

腹腔镜甲状腺手术器械 Thyroid Operating Instrument

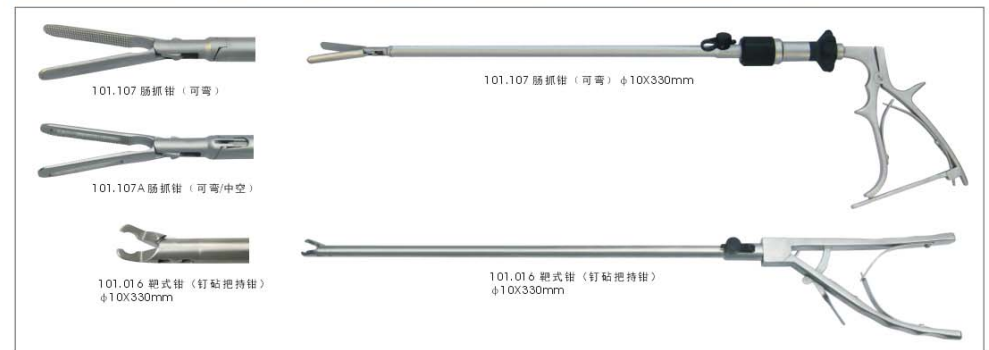
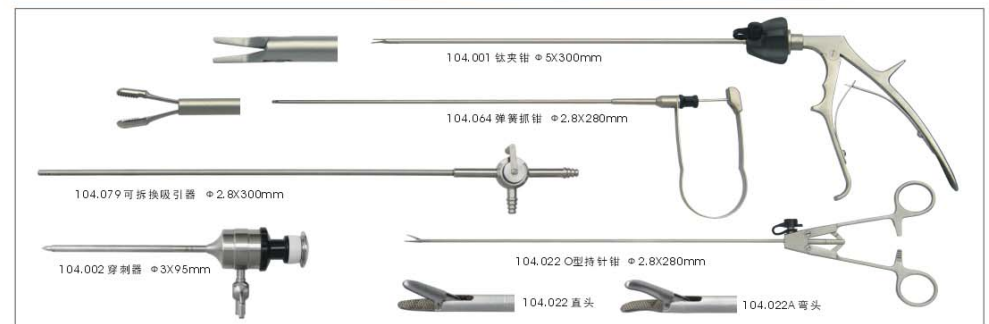
OC-102 腹腔镜结、直肠手术器械 Colon and Rectum Instruments

OC-104 微型腹腔镜手术器械 Miniature Instruments

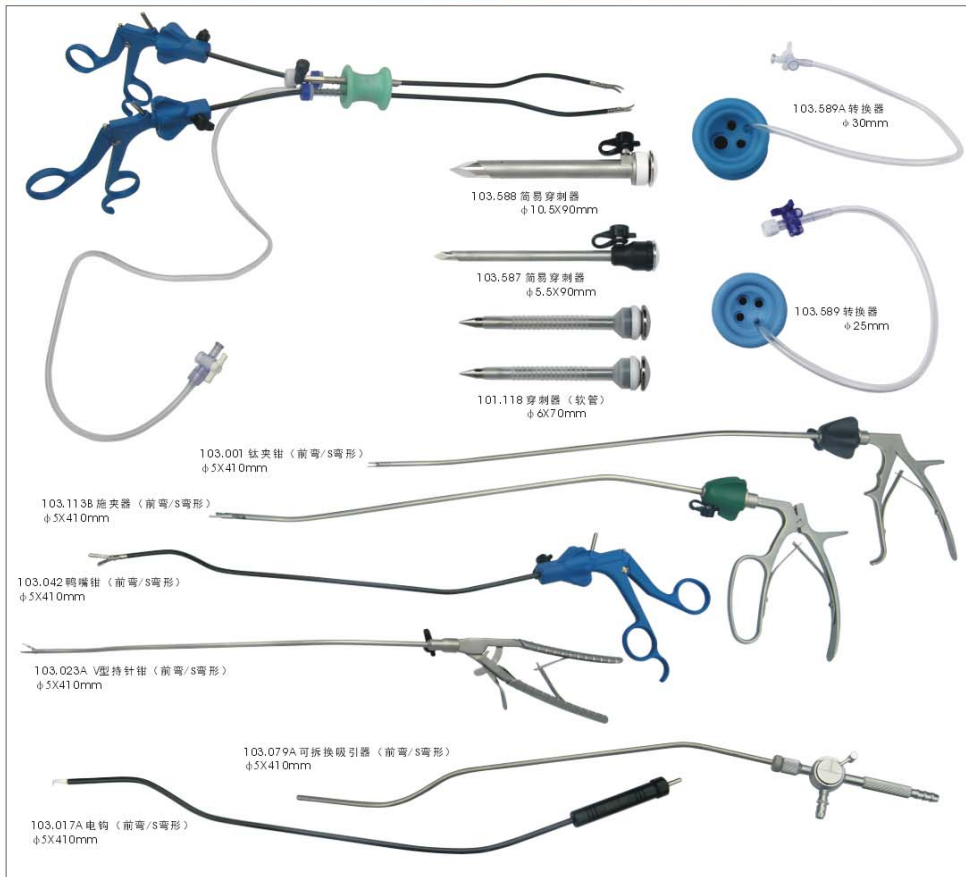
OC-103 单孔腹腔镜手术器械 Instrument For SILS

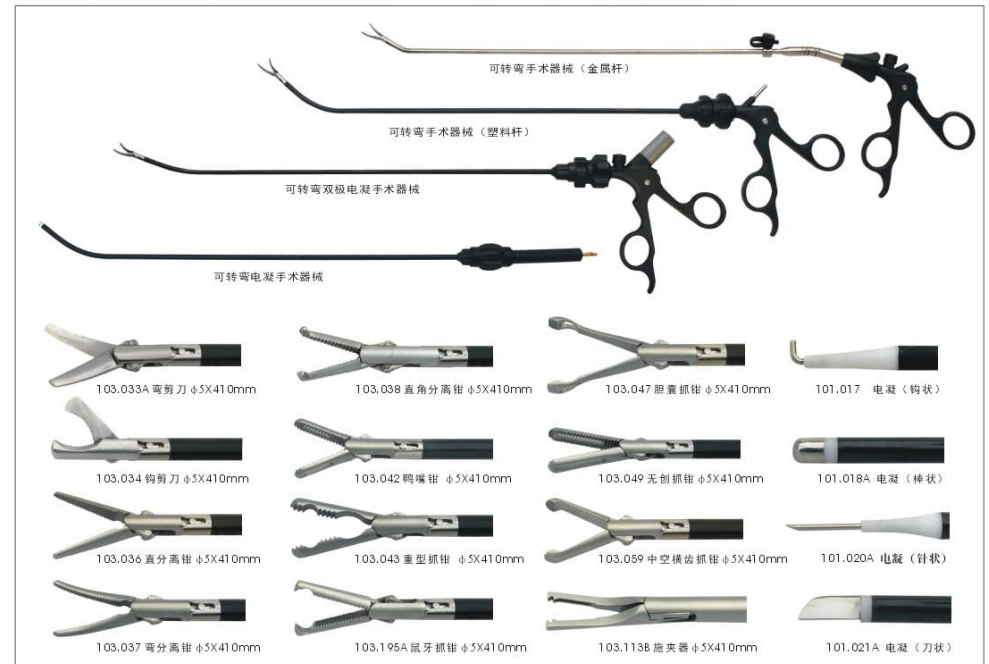

可转弯手术器械 Flexible Instrument



简易举宫器 Uterine Manipulator



多功能举宫器 Uterine Manipulator Set



特种举宫器 Uterine Manipulator

301.027A 特种举宫器



301.027C 特种举宫器



301.027D 特种举宫器



301.027E 双头举宫器



301.027F 举宫球

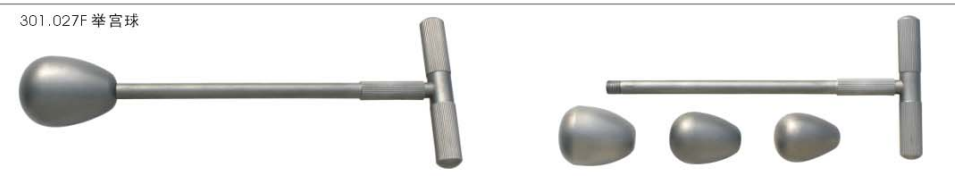

大圆棒、小圆棒、肌瘤分离器 Small rod, Big rod, Separator



OC-302新式非脱垂子宫经阴道切除手术器械 Vaginal Instruments



OC-303型妇产科手术器械包 Gynecology Surgical Instruments Set

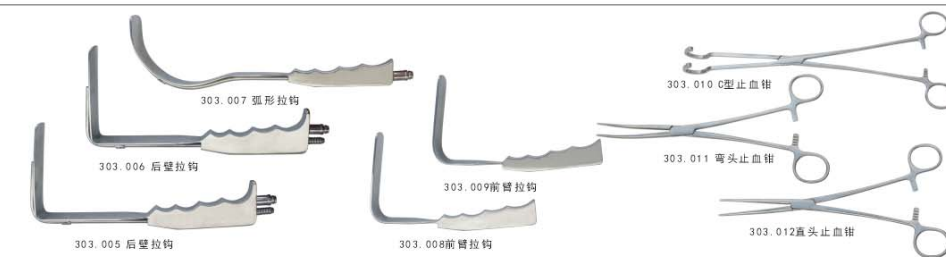

OC-301 电子子宫切除器 Morcellator



OC-301 电子子宫切除器 Morcellator

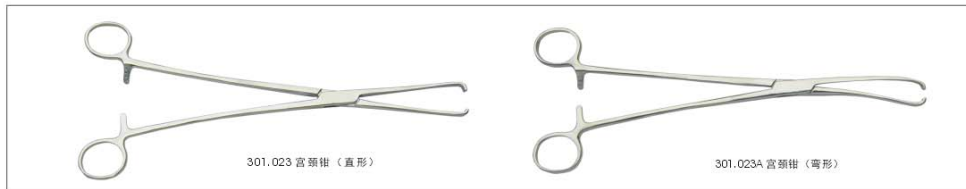

OC-301B 电动子宫切除器 (简配) Morcellator

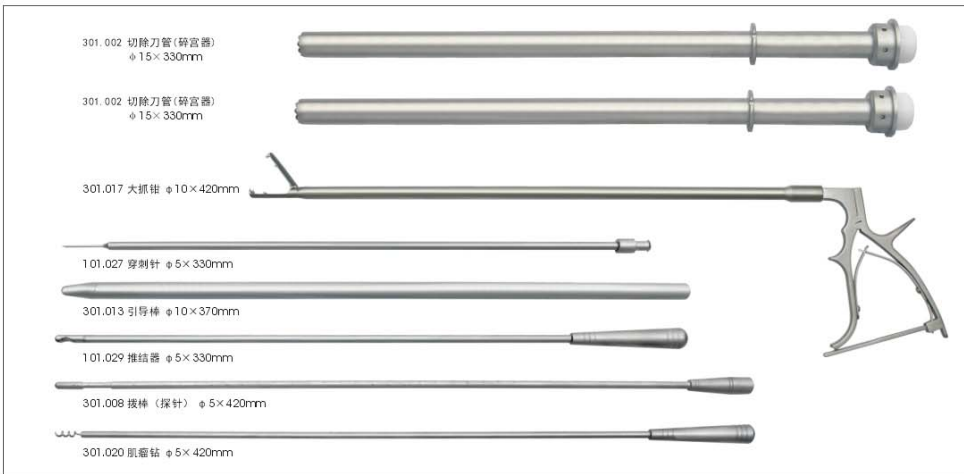

一次性使用医疗器械 Disposable Instruments

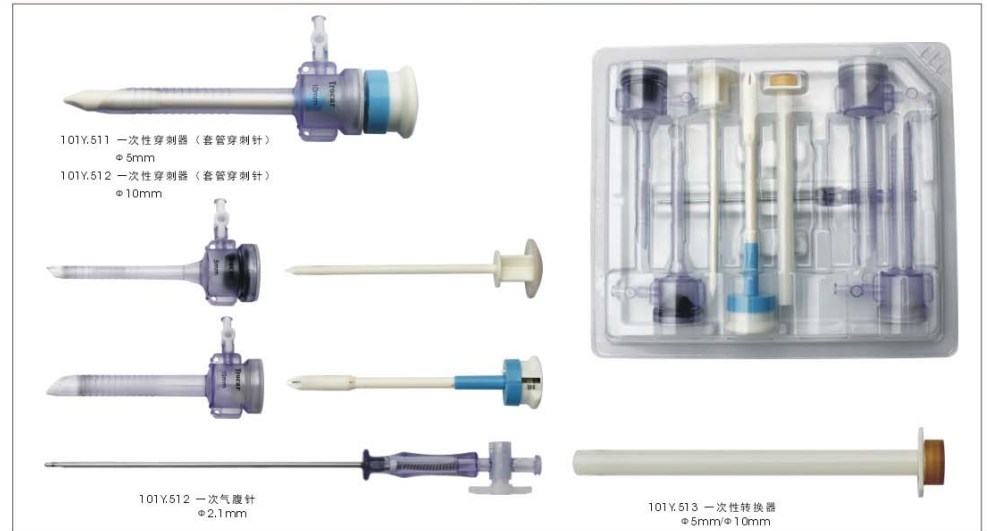

消毒盒 Sterilization Case



腹腔镜电气、电子设备 Endoscopic Equipments

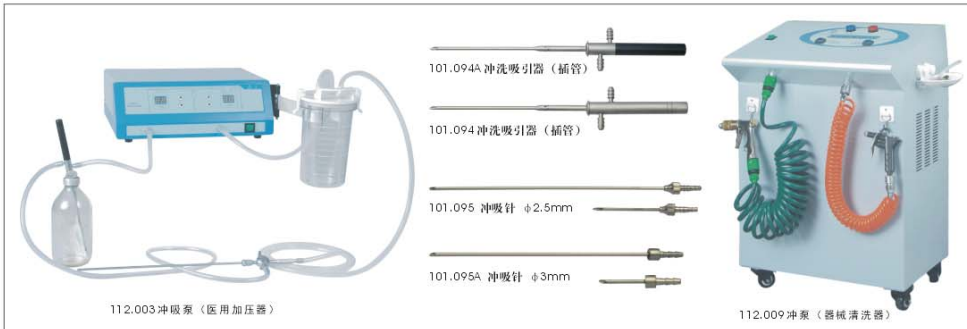

1CCD影像工作站

显示器 17"、19" LCD
DVD摄像头
内窥镜接口
计算机主机 方正或联想
打印机 Hp6000 彩箱
脚踏开关
高档铝合金多功能台车
腹腔镜专用软件

3CCD影像工作站

显示器 17"、19" LCD
DVD摄像头
内窥镜接口
计算机主机 方正或联想
打印机 Hp6000 彩箱
脚踏开关
高档铝合金多功能台车
腹腔镜专用软件

数字高清影像工作站

显示器 21" LCD
DVD摄像头
内窥镜接口
计算机主机 DELL E-2400
打印机 HP6000 彩箱
脚踏开关
高档铝合金多功能台车
腹腔镜专用软件

宫腔镜 Hysteroscope

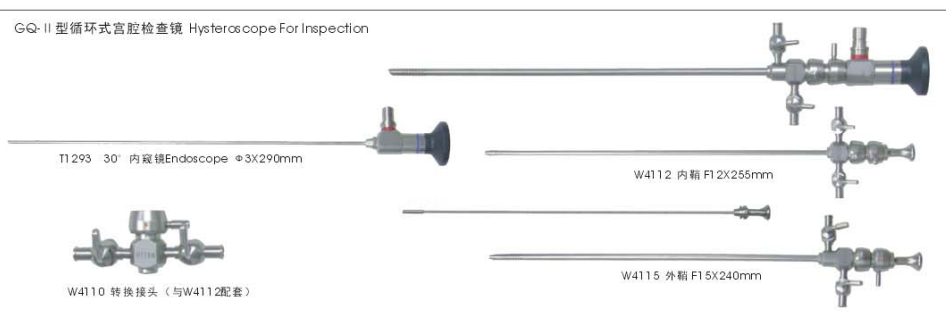
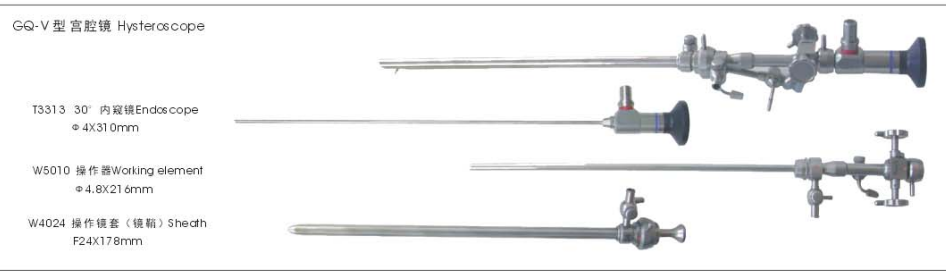

DQH-II 型宫腔电切镜 (宫腔手术用) Hystero-Electrotome

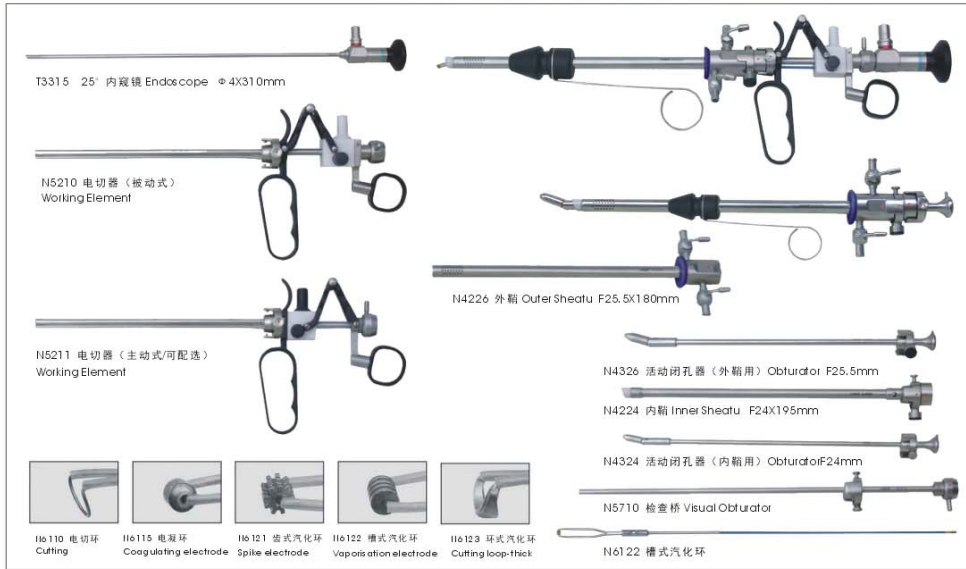

PG-VA型尿道膀胱镜 Systo-Urethroscope

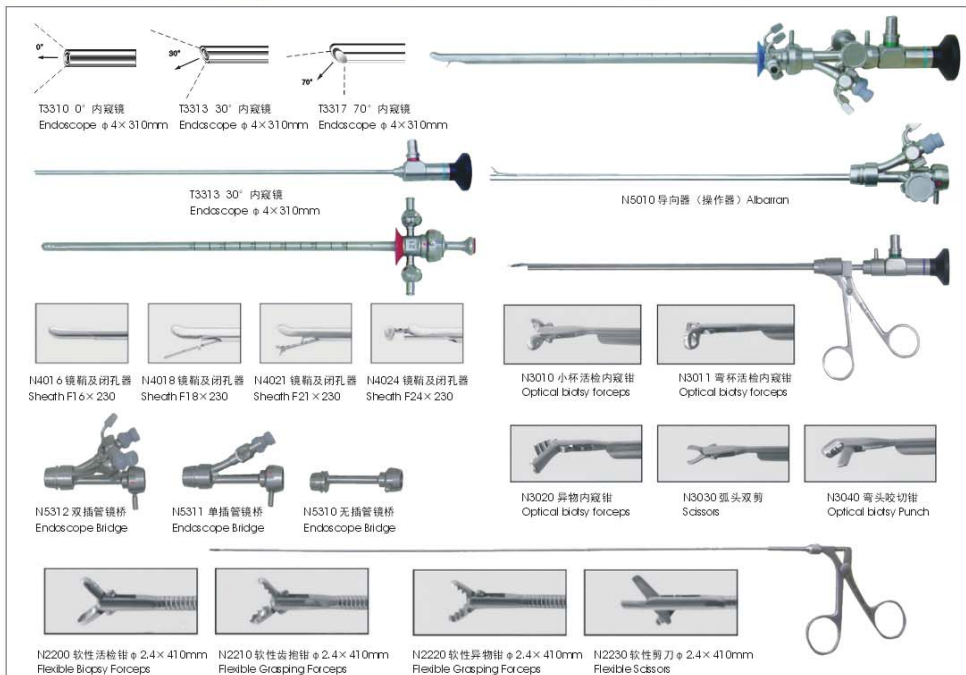

PG-VC型侧视式尿道膀胱镜 (弹道碎石镜) Side Viewing Systo-Urethroscope

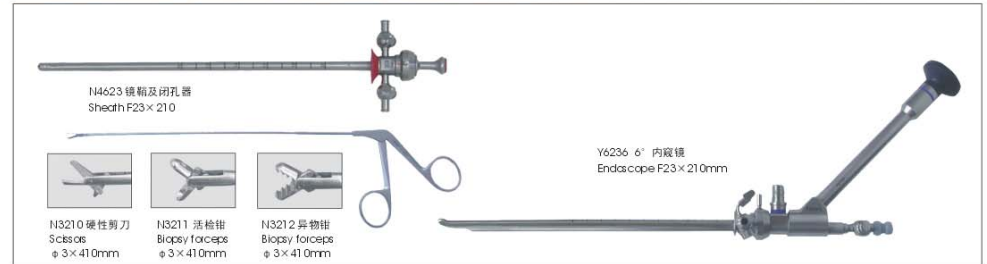

PQH-III型膀胱电切镜 (汽化) Resectoscope for Adults

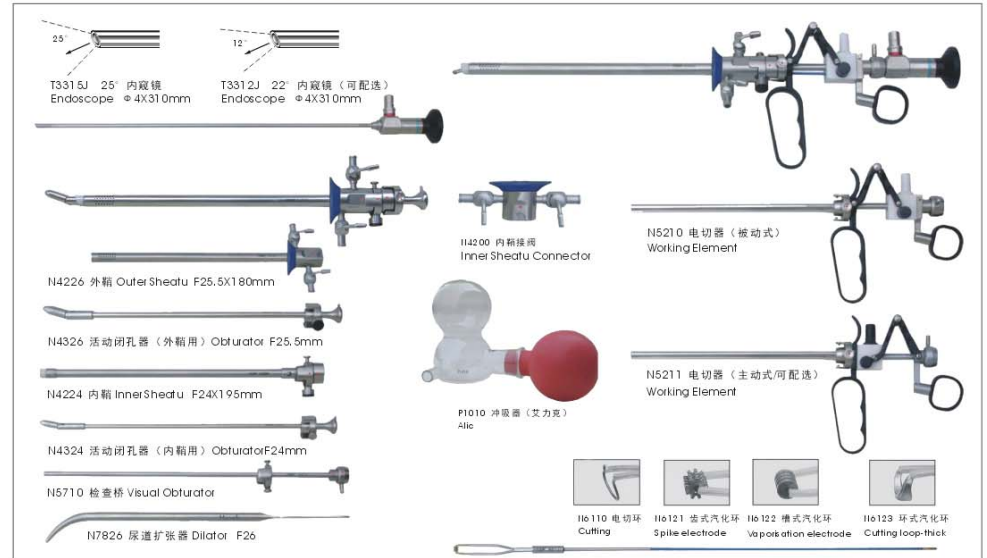

NQ-II 型尿道切开镜 Optical Urethrotome



膀胱碎石镜 Lithotripsy scope

DS-II 型膀胱碎石镜 (大力碎石) Lithotripsy scope

- T3317 70° 内窥镜 φ4×310
- N3110 大力碎石钳 F24×230
- N4024 镜鞘及闭孔器 F24×230
- P1010 冲吸器 (艾利克)
- N5310 无插管镜桥
- P1801 导光束 φ4×1800



NS-II 型膀胱碎石镜 (咬式碎石) Lithotripsy scope

- T3313 30° 内窥镜 φ4×310
- N3130 咬牙碎石钳 F24×230
- N4024 镜鞘及闭孔器 F24×230
- P1010 冲吸器 (艾利克)
- P1801 导光束 φ4×1800



DS-II 型膀胱碎石镜 (拉式碎石) Lithotripsy scope

- T3310 0° 内窥镜 φ4×310
- N3120 拉牙碎石钳 F24×230
- N4024 镜鞘及闭孔器 F24×230
- P1010 冲吸器 (艾利克)
- P1801 导光束 φ4×1800



输尿管肾镜 Uretero Renoscope

SN-I 型输尿管肾镜 Uretero Renoscope

- 镜头 φ1mm
- 导光束
- 器械通道 φ2mm



Y1430 输尿管肾镜 F8.5X430

SN-III 型输尿管肾镜 (经皮肾镜) Uretero Renoscope

- 镜头 φ1mm
- 导光束
- 器械通道 φ2.2mm



Y1330 输尿管肾镜 F12X330

ST-II 型食道镜 (光纤导光) Uptodate oesophagoscope

- T3370 0° 内窥镜 φ4X470mm



Q5230 光导食道镜 9X1.0.6X270mm

Q4060 吸引管 (大号)

- Q1011 钩嘴钳
- Q1021 抱式钳
- Q1031 鸭嘴钳
- Q1051 杯形钳

YS-I 型乙状结肠镜 (光纤导光) Sigmoidoscope



T3330 30° 内窥镜 φ4X330mm

Q5140 光导肛门镜

Q5110 光导检查镜

Q5150 镜筒

Q4072 吸引管 (大号)



P1013 清洗刷

Q1200 棉花钳

Q1100 活枪钳

耳用微型手术器械 Otolaryngology instruments



R1010 中耳剪

R1040 直形耳钳

R1250 弯形耳钳

R1260 刮匙

R1270 刮匙

R1400 楔形钩 (钝)

R1410 楔形钩 (锐)

R1020 短麦粒钳

R1050 锥骨安装钳

R1280 开窗匙 (右弯)

R1290 开窗匙 (左弯)

R1300 圆凿 (直)

R1310 圆凿 (弯)

R1320 平凿

R1030 上弯耳钳

R1060 锥骨头钳

R1340 锥骨针

R1350 耳用钩 (钝)

R1360 耳用钩 (锐)

R1370 耳用钩 (锐)

R1380 耳用钩 (钝)

R1390 耳用钩 (锐)

耳用手术电钻 Otolaryngology electric-drill



R1530 控制器

R1520 手机马达

R1510 弯机头

R1500 直机头

R1540 脚踏开关

R1601 钨钢钻头 φ5mm

R1602 钨钢钻头 φ4mm

R1603 钨钢钻头 φ2mm

R1604 钨钢钻头 φ1mm

R1605 钨钢钻头 φ0.8mm

YSB型刨削器 (鼻窦手术用) Nose electric-drill



B7410 控制器

B7400 手机马达及连线

B7050 多功能脚踏开关

B7412 平切刀

B7413 相切刀

B7414 中切刀

B7415 打磨刀

B7300 清洗刷

XQG-II 型气管镜 Bronchoscope



T1370 0° 内窥镜 Endoscope φ3×370mm

Q4020 光纤镜鞘 φ5.8×270mm

Q4060 吸引管 φ4mm

Q3010 颊口内窥镜

Q3020 花生内窥镜

Q1010 异物钳

Q1020 花生钳

Q1030 圆口钳

Q1040 鼠牙钳

BD-III A型鼻窦镜 Sinoscope

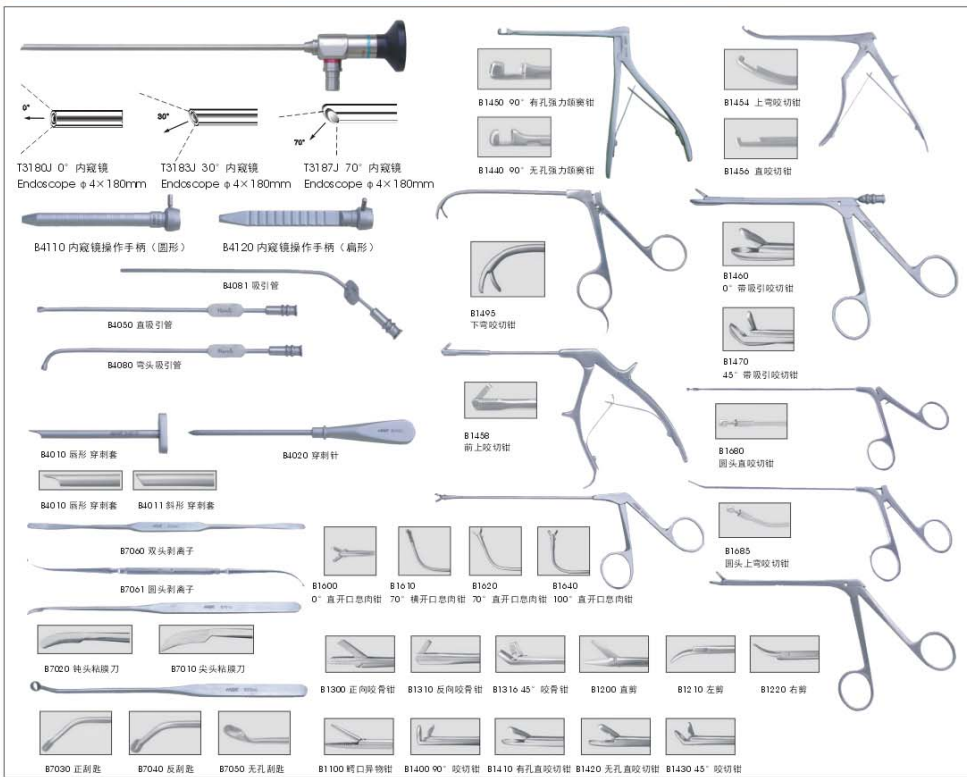

喉镜 Laryngoscope



ZH-III 型喉镜 (显微支撑) Laryngoscope



耳镜 Otoscope



脑室镜 Ventriculoscope

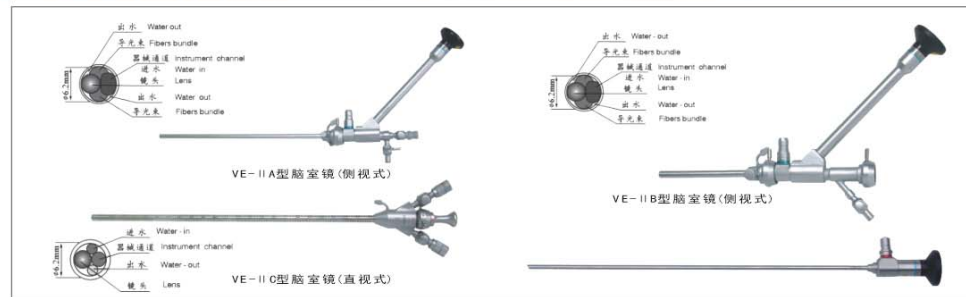

GJ-V 关节镜 Arthroscope



椎间盘镜手术器械 Surgical for intervertebral endoscope

