



## ENDOSCOPE SERIES SURGICAL INSTRUMENTS

Address: No. 939 Southern Huangcheng Road, Tonglu City, Hangzhou, Zhejiang Province  
Post code: 311599  
Email: [info@geyi-medical.com](mailto:info@geyi-medical.com)



HANGZHOU EUPRUN MEDICAL INSTRUMENT CO.,LTD.



HANGZHOU EUPRUN MEDICAL INSTRUMENT CO.,LTD.

Hangzhou Euprun Medical Instrument Co.,Ltd is located in the beautiful Fuchun River-Tonglu. The factory covers an area of 12000squaremeters. And it is a new and national high-tech enterprise integrated research, development and marketing of medical endoscopic surgical instruments. The company has obtained the certification of ISO9001 and ISO13485 Medical Device Quality Management System.

The company is committed to brand marketing, and adheres to the road of specialization, industrialization and large-scale and conforms industry superiority. Currently, the company has a good reputation and visibility in the same field and among the customers. Meanwhile, the company is the best of the best in the field of minimally invasive surgical instruments.

In the management team, 80% members hold college diploma or above. And 90% front-line workers or more had received professional training. Additionally, their abilities had been strengthened and improved in the actual operation. At present, the company had formed a team with professional management, research, development and marketing and excellent after-sale service.

The company bases on the enterprise spirit of "work together be better" and follows the tenet "Quality is life, the users are families". Besides, the company who depends on its strong production capacity, good brand image and steady management mechanism will provide more perfect, excellent and effective service for customers and finally achieves its mission "Only for people's health".



## Contents

### Laparoscopic Instruments

Laparoscope. Trocar and Sealing cap	01
Reducer. Aspiration Needle. Bile Duct Knife. Monopolar HF Electrode	02
Veress Needle. Suction & Irrigation. Golden Scissor. Bipolar	03
Cord for Monopolar/ Bipolar. Clip Applier. Polymer Ligation Clip	04
Open Titanium/ Polymer Clip Applier. Clip Remover. Titanium clip. Clip Applier	05
Purse Stitching Clamp. Artery / Vein Clip. Clip Applier. Knot Pusher. Clip Applier	06
Needle Holder	07
Closure Forceps. Retractor. Distraction Forcep	08
Spring Grasping Forcep. Biliary-Lithotomy Forcep. Golden Finger	09
Nerve Retractor. Liver Retractor. Bendable Forcep. Cholangiography Forcep	10
Scissor Dissector Grasper Instrument	11-16
Miniature Instruments	17
Single Port Instruments (SILS)	18
Detachable Picture of Instrument	19

### Thyroid Surgical Instruments

Thyroid Surgical Instruments	20
------------------------------	----

### Gynecology Surgical Instruments

Manipulator	21-22
Morcellator. Gynecology Surgical Instruments	23-25

### Sterilization Case

Sterilization Case	26
--------------------	----

### Medical Equipment

Light Source. Insufflator. Irrigation Pump. Laparoscopic Simulator	27
Endoscopy Tower/Rack	28

### Endoscopes

Hysteroscope	31
--------------	----

## Laparoscopic Instruments

### Laparoscope

0° Laparoscope  
Φ10×330mm  
Φ5×330mm



30° Laparoscope  
Φ10×330mm  
Φ5×330mm



### Trocar and Sealing Cap

flip type

801.008.1 Φ12.5 × 95mm  
801.004.1 Φ10.5 × 95mm  
801.003.1 Φ5.5 × 95mm



flip type( with autoshield safety)

801.163.1 Φ12.5 × 95mm  
801.075.1 Φ10.5 × 95mm  
801.076.1 Φ5.5 × 95mm



cross-shaped

801.008 Φ12.5 × 95mm  
801.004 Φ10.5 × 95mm  
801.003 Φ5.5 × 95mm  
804.002 Φ3.5 × 60mm

cross-shaped( with autoshield safety)

801.163 Φ12.5 × 95mm  
801.075 Φ10.5 × 95mm  
801.076 Φ5.5 × 95mm



magnetic type

801.008.3 Φ12.5 × 95mm  
801.004.3 Φ10.5 × 95mm  
801.003.3 Φ5.5 × 95mm



magnetic type(with autoshield safety)

801.163.3 Φ12.5 × 95mm  
801.075.3 Φ10.5 × 95mm  
801.076.3 Φ5.5 × 95mm



flip type

801.003.2 Φ5 × 95mm  
801.004.2 Φ10 × 95mm

flip type( with autoshield safety)

801.076.2 Φ5 × 95mm  
801.076.2 Φ5 × 95mm



802.008,trocar with metal thread,Φ5.5mm



802.009,trocar with metal thread,Φ8.5mm



802.010,trocar with metal thread,Φ10.5mm



802.011,trocar with metal thread,Φ12.5mm



801.108,new threaded trocar Φ5.5×88mm



801.109,new threaded trocar Φ10.5×88mm



801.086.2,Φ10.5mm sealing cap/washer



801.086.1,Φ5.5mm sealing cap/washer

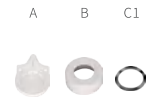

801.086,Φ3mm sealing cap/washer

### Reducer

801.010 sleeve type, Φ10.5-Φ5.5mm



801.010 100mm  
801.010.1 120mm  
801.010.2 150mm  
801.010.3 170mm



801.010.4 22mm



801.145 bayonet type Φ10.5-Φ5.5mm



801.146 screw type Φ10.5-Φ5.5mm

### Aspiration needle

801.027Φ5×330mm

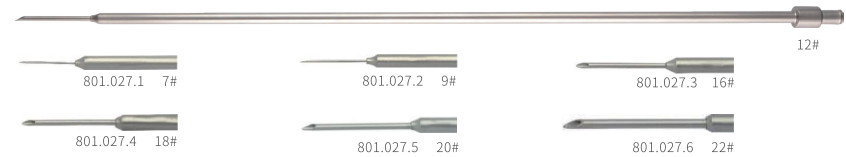

801.027.1 7#

801.027.2 9#

801.027.3 16#

801.027.4 18#

801.027.5 20#

801.027.6 22#

### Bile duck Knife

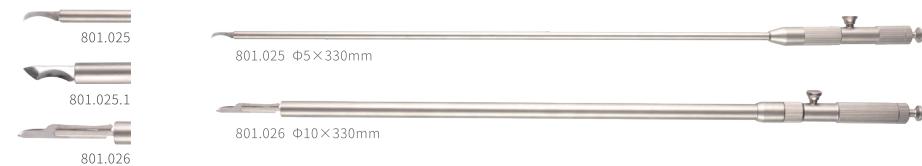

801.025

801.025 Φ5×330mm

801.025.1

801.026 Φ10×330mm

801.026

### Monopolar HF Electrode



Φ5×330mm

808.017 monopolar hook electrode "L"



808.017.1 monopolar sharp "L" hook



808.017.2 monopolar electric hook



808.017.3 monopolar hook electrode "J"



808.021.1 monopolar electric knife



808.018.1 monopolar coagulation



808.019.1 monopolar electric spade



808.020.1 monopolar electric pin



### Veress Needle

- 801.011  $\Phi 2.2 \times 110\text{mm}$
- 801.011.1  $\Phi 2.2 \times 120\text{mm}$
- 801.011.2  $\Phi 2.2 \times 150\text{mm}$



801.231 Veress Needle Connector



### Suction & Irrigation

$\Phi 5/\Phi 10 \times 330\text{mm}$

- 801.079 push type
- 801.079.1 push type (big valve)
- 801.079.2 push type (small valve)



$\Phi 5/\Phi 10 \times 330\text{mm}$

- 801.149 spring type



### 5mm Golden Scissors

- 801.033.1JB Golden Scissors

$\Phi 5 \times 330\text{mm}$



### Bipolar

$\Phi 5 \times 330\text{mm}$

- 808.044 Bipolar Forceps (screwed)



808.044 doubleaction (straight)



808.044.1 doubleaction (curved)



$\Phi 5 \times 330\text{mm}$

- 808.045 Bipolar Forceps (three partition)



808.045.1 double action (straight)



808.045.2 single action (curved)



808.045.3 double action (curved)



808.045.5 single action (round shaped)

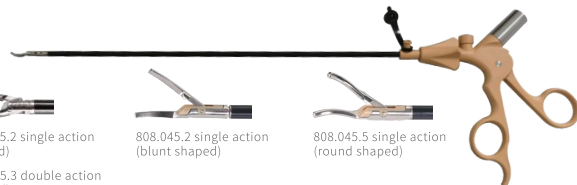

### Cord for Monopolar



808.082 Cord for Monopolar  $\Phi 4 \times 3000\text{mm}$



808.082.1 match OLYMPUS  $\Phi 8\text{mm}$



808.082.2 ordinary connector or  $\Phi 6\text{mm}$



808.082.6 match HUTONG  $\Phi 6.3\text{mm}$

### Cord for Bipolar



808.039 Cord for Bipolar 3000mm (match three partition handle)



808.039.1 Cord for Bipolar (match blue handle)

### Clip Applier, Polymer Ligation Clip



801.113, XL,  $\Phi 10 \times 330\text{mm}$ , matches 805.621

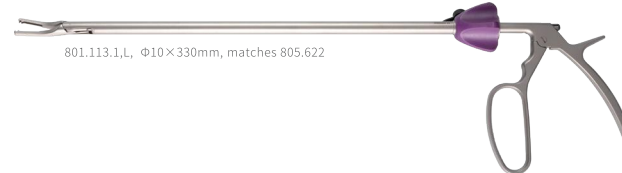

801.113.1,L,  $\Phi 10 \times 330\text{mm}$ , matches 805.622

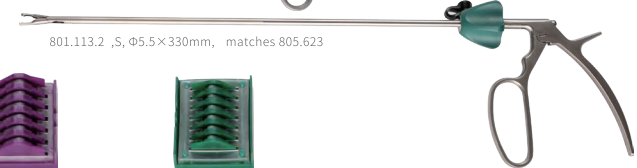

801.113.2 ,S,  $\Phi 5.5 \times 330\text{mm}$ , matches 805.623



805.621, XL



805.622, L



805.623, S



804.114.1, Articulated,  $\Phi 10 \times 330\text{mm}$ , L, matches 805.622



804.114, Articulated,  $\Phi 10 \times 330\text{mm}$ , L, matches 805.621

### Open Titanium Clip Applier



### Open Polymer Clip Applier



### Clip Remover



### Titanium Clip,Clip Applier

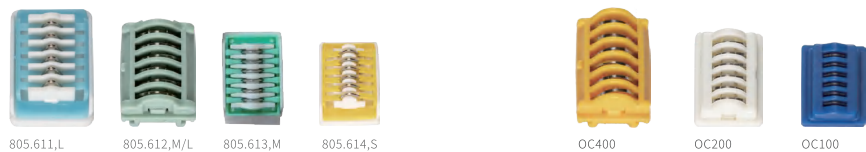

### Purse Stitching Clamp



### Artery/Vein Clip,Clip Applier

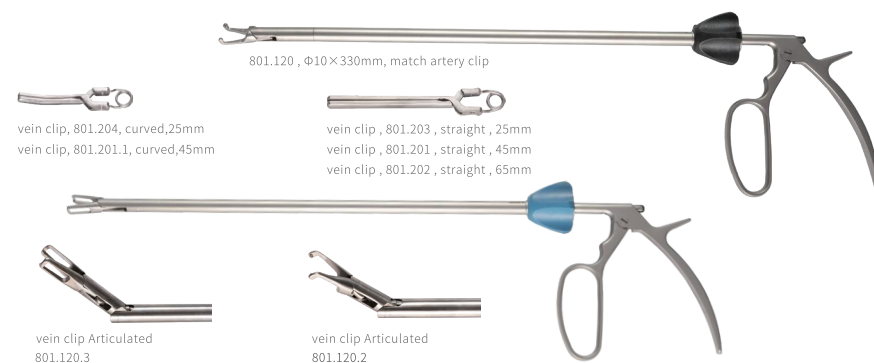

### Knot Pusher



### Clip Applier

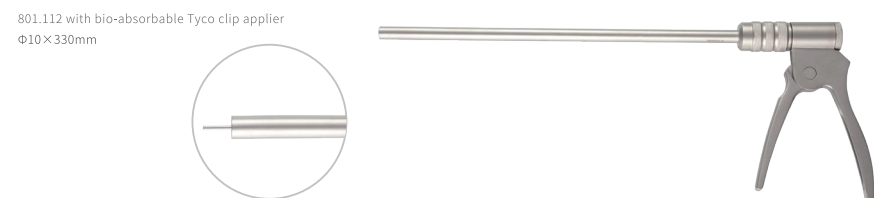

## Needle Holder



## Closure Forceps

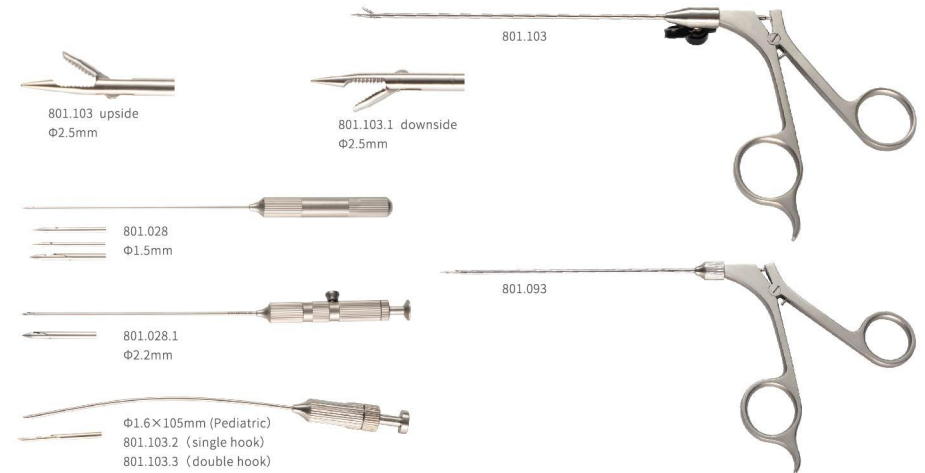

## Three Leaves Retractor and Five Leaves Retractor



## Distraction Forceps(three leaves retractor)



801.066



Spring Grasping Forcep

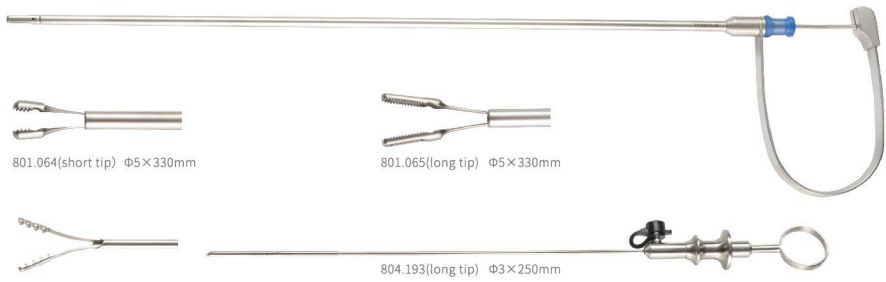

Biliary Tract-Lithotomy Forcep



Golden Finger



Vein/Nerve Retractor



Live Retractor



Bendable forceps



Cholangiography forceps



Φ5×330mm Forceps and Scissors

Handle Φ5mm



801F.001 insulated handle (two partition)



801F.002 insulated handle with ratchet (two partition)



801F.003 insulated handle (three partition)



801F.004 insulated handle (three partition, with ratchet)



801F.013 insulated handle



801F.011 insulated handle

	801.032 straight scissors (single action)		801.133 claw forceps
	801.032.1 straight scissors (double action)		801.037 Maryland forceps 17mm
	801.033 curved scissors (single action)		801.037.1 Maryland forceps 12mm
	801.033.1 curved scissors (double action)		801.037.2 Maryland forceps 14mm
	801.033.2 micro-curved scissors (double action)		801.037.3 Maryland forceps 18mm
	801.034 hook scissors		801.037.4 Maryland forceps 20mm
	801.035 upwards scissors		801.037.5 Maryland forceps 25mm
	801.033.1B insulated scissors		801.037.6 blunt tip Maryland forceps 16mm
	801.036 straight grasper		801.037.7 Maryland forceps (45°)
	801.051 dolphin nose grasper		801.037.8 Maryland forceps (70°)

	801.037.9 Maryland forceps (70°) Mesh tooth		801.195.1 grasper 1+2teeth, double action
	801.038 Mixer right angle		801.031 knot forceps
	801.038.1 Mixer right angle (wider head)		801.044.1 reverse-teeth forceps
	801.038.3 ligature clamp		801.047 cholecystic forceps
	801.037.1 insulated maryland forceps		801.047.1 nine teeth cholecystic forceps
	801.049 fenestrated grasping forceps		801.054 biopsy forceps sharp cupped jaw
	801.048.1 grasping forceps		801.105 claw forceps 2+4teeth, single action
	801.048.2 grasping forceps		801.105.1 claw forceps 2+4teeth, double action
	801.052 appendix grasping forceps		801.044.2 reverse-teeth forceps





801F.005 stainless steel handle





















801F.006 stainless steel(self-locking)







801F.008 stainless steel(with upper ratchet)



801F.007 stainless steel handle (with down ratchet)

	801.031.1 B-shaped knot forceps		801.050 bullet nose forceps
	801.062.1 V-shaped grasping forceps		801.057 fallopian tube grasping forceps
	801.061 O-shaped grasping forceps		801.042 duck-jaw grasping forceps
	801.198.1 stomach grasping forceps,curved		801.042.1 duck-jaw grasping forceps coarse teeth
	801.134 babcock grasping forceps		801.043 Maxi grasper
	801.198 stomach forceps (double action)		801.044 reverse-teeth forceps
	801.055 biting&cutting forceps		801.046.1 grasper 2+3 teeth (double action)
	801.057.1 Oviduct forceps		801.058 mucous membrane forceps hollow
	801.053 cupped biopsy forceps		801.058.2 mucous membrane forceps

	801.030 knot forceps S shape		801.059 hollow erect grasping forceps
	801.061 O-shaped grasping forceps		801.056.1 Debakey grasping forceps(hollow)
	801.059.1 hollow erect grasping forceps, long tip		801.056 Debakey grasping forceps
	801.060.1 Allis grasper longer tip		801.072.2 sector forceps
	801.062 V-shaped grasping forceps		801.116 ureteral grasping forceps
	801.045 organ-anchoring grasper		801.056.3 bowel forceps
	801.048 atraumatic forceps		801.056.4 intestinal grasping forceps
	801.049.1 fenestrated grasping forceps		801.018.1 Walf claws grasping forceps
	801.049.2 endo(lap)clinch fenestrated grasper		

Φ10mm×330mm Forceps and Scissors

Handle(Φ10mm)



801F.010 insulated handle  
(two partition)



801F.012 insulated handle  
(three partition)

	801.012.2 biopsy forceps matches 801F.010		801.041.1 Mixer dissecting forceps matches 801F.010
	801.039.2 straight scissor matches 801F.010		801.040.2 curved scissors matches 801 F.010
	801.013.2 claw forceps only matches 801F.010		801.012 biopsy forceps matches 801F.016
	801.041 dissecting forceps(right angle) matches 801F.010		801.135 grasping forceps(eight claws) 801F.017
	801.041 dissecting forceps(right angle) matches 801F.010		802.007 (duck-jaw grasping forceps) matches 801F.017
	801.013 claw forceps matches 801F.017		801.014 atraumatic grasping forceps 801F.017













801F.015 stainless steel handle,can not be detached by hands(self-locked)



801F.016 stainless steel handle,can not be detached by hands



801F.017 stainless steel handle,can not be detached by hands(with down ratchet)

	801.069 stomach grasping forceps round tip,matches 801F.017		802.002 lobe grasping forceps matches 801F.017
	801.071 anastomotic and tractive grasping forceps matches 801F.017		801.130 US Babcock grasping matches 801F.017
	801.126 reverse teeth matches 801F.017		801.107 gut grasping forceps bendable, matches 801F.017
	802.004 toothless grasping forceps (with wide mouth) matches 801F.017		802.005 grasping forceps (with long chin)matches 801F.017
	801.121 oval grasping forceps matches 801F.017		801.235 interdiction vessel forceps, matches 801F.017
	801.068 stomach grasping forceps matches 801F.017		801.070 suture grasping forceps, matches 801F.017

OC-804 Miniature Instruments for children and Pediatric surgery

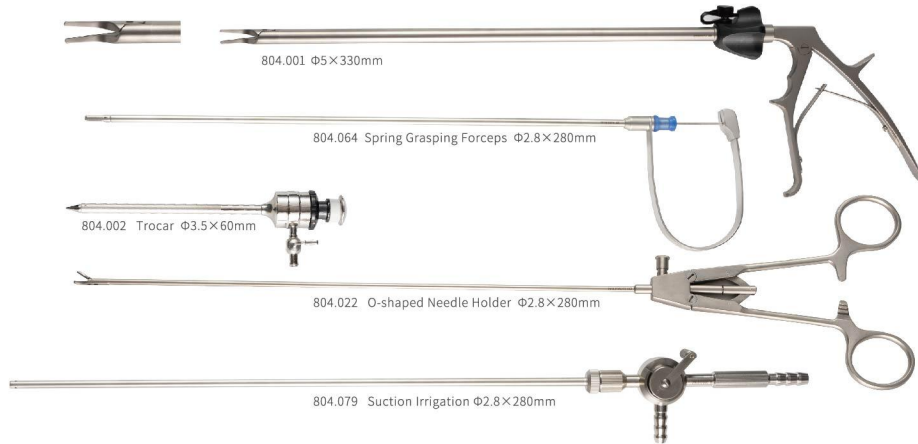

$\Phi 2.8 \times 280\text{mm}$

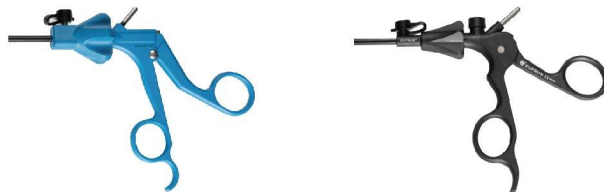

Instrument FOR SILS/Single Port Instruments

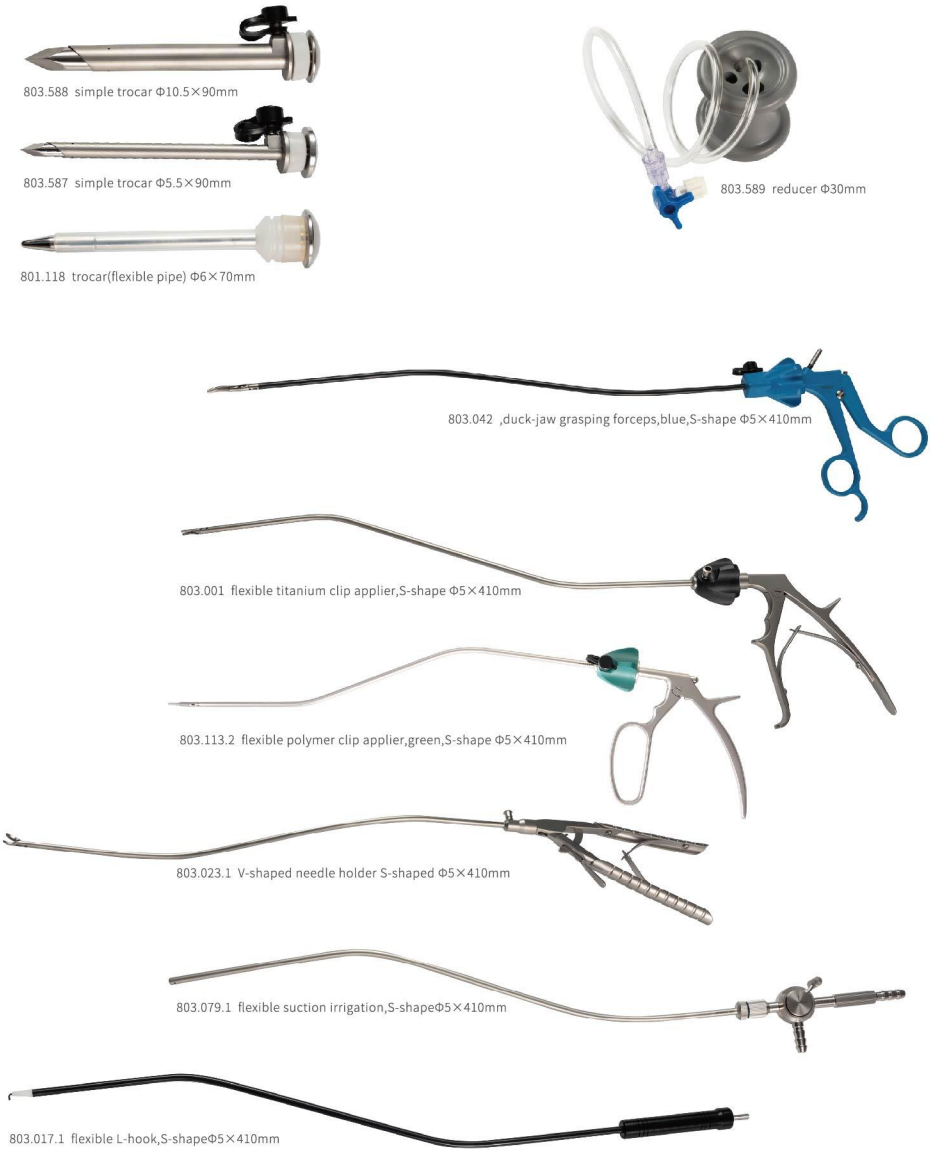

## Detachable Picture of Instruments

Two partition handle

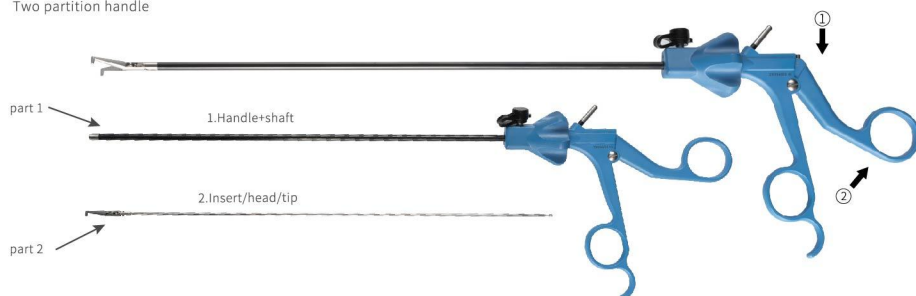

Three partition handle



### Assembly Instructions Applicable to Table 1

1. Press button 1, keep handle left part still, and pull the right part 2 till button 1 hidden inside.
2. Slide insert into handle, notice the tongue and groove configuration. The insert should snap firmly into the shaft.
3. Close handle part 2, till you hear a 'click' sound, make sure the insert fits the handle completely.

### Disassembly Instructions Applicable to Table 1

1. Press button 1, keep handle left part still, and pull the right part 2 till button 1 hidden inside.
2. Keep pulling 2, till the insert slide out of the handle.
3. Pull out of the insert from the handle.

### Assembly Instructions Applicable to Table 2

1. Plug in insert into shaft, keep insert upside and make sure it fits shaft slot perfectly, rotate it clockwise and keep the jaw close.
2. Pull handle 2 part to it's MAX position.
3. Insert shaft into handle till the end of insert touches the handle.
4. Close handle slightly till you hear a 'click' sound.

### Disassembly Instructions Applicable to Table 2

1. Press 'PRESS' button, keep handle left part still, and pull the right part 2.
2. Keep pulling 2, till the insert slide out of the handle.
3. Keep jaws open and upside, rotate counterclockwise, and slide insert from the shaft.

## Thyroid Surgical Instruments

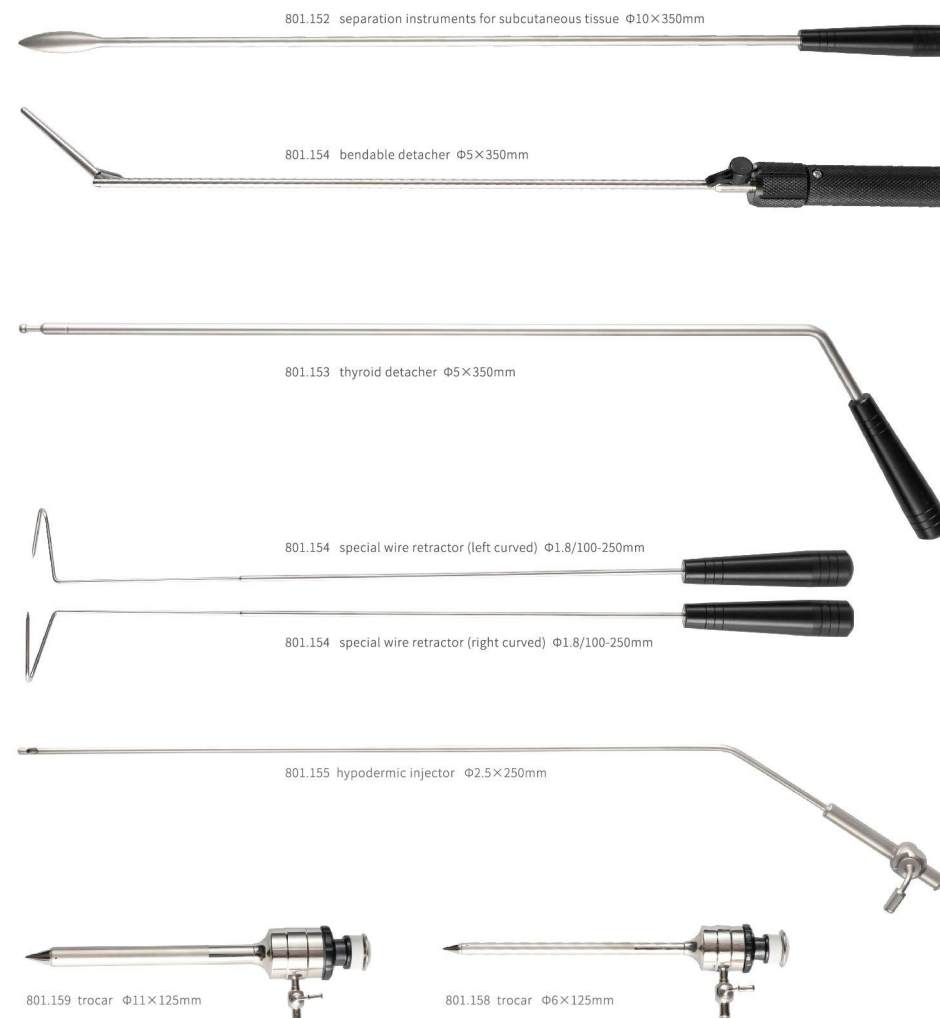



Gynecology Surgical instruments

Uterine Manipulator Set

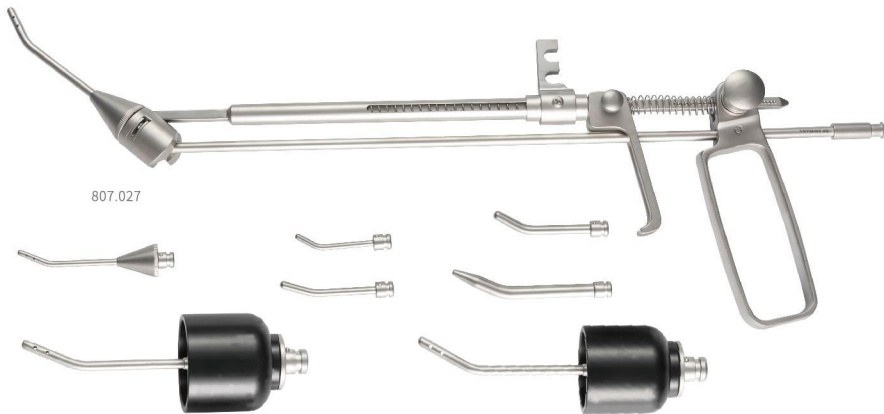

Uterine Manipulator

807.027.2 Uterine Manipulator



807.027.3 Uterine Manipulator



807.072.7 Uterine Manipulator



807.072.5 Cup Type Uterine Manipulator



Uterine Manipulator



807.026.1 (7mm)

- 807.026.2 adjustable
- 807.026.3 with suction
- 807.026.4 size:S
- 807.026.5 size:M
- 807.026.6 size:L



OC-807 Morcellator



OC-807 Morcellator



807.014 reducer Φ15-Φ10mm



807.015 reducer Φ18-Φ10mm



807.011 dilator Φ15mm



807.012 dilator Φ18mm



807.009 trocar cannula Φ15×95mm



807.010 trocar cannula Φ18×95mm

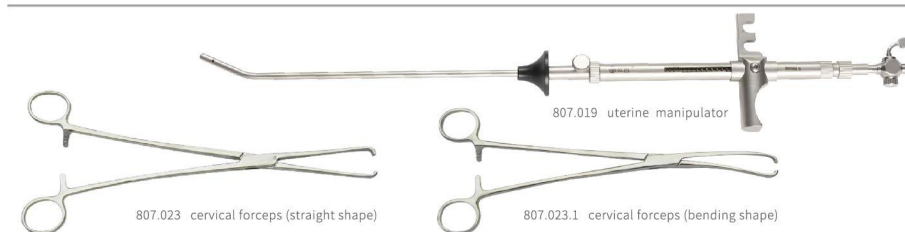

807.036 electric motor core (MAX motor-Switzerland)



807.037 electric motor cable



807.025 electric motors handle



Power cord



807.024 controller(LCD display)

OC-807.1 Morcellator

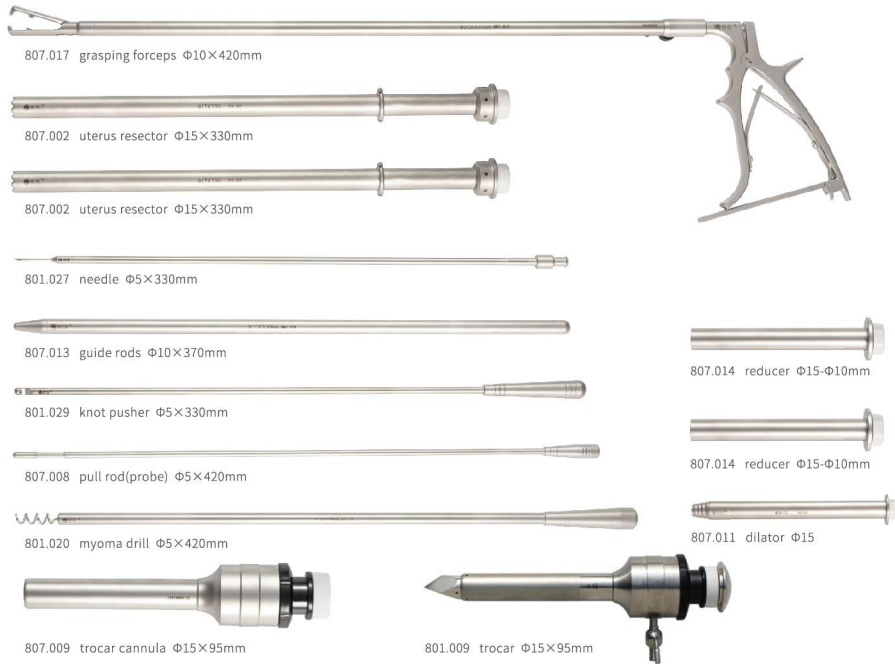

807.017 grasping forceps  $\Phi 10 \times 420\text{mm}$

807.002 uterus resector  $\Phi 15 \times 330\text{mm}$

807.002 uterus resector  $\Phi 15 \times 330\text{mm}$

801.027 needle  $\Phi 5 \times 330\text{mm}$

807.013 guide rods  $\Phi 10 \times 370\text{mm}$

801.029 knot pusher  $\Phi 5 \times 330\text{mm}$

807.008 pull rod(probe)  $\Phi 5 \times 420\text{mm}$

801.020 myoma drill  $\Phi 5 \times 420\text{mm}$

807.014 reducer  $\Phi 15-\Phi 10\text{mm}$

807.014 reducer  $\Phi 15-\Phi 10\text{mm}$

807.011 dilator  $\Phi 15$

807.009 trocar cannula  $\Phi 15 \times 95\text{mm}$

801.009 trocar  $\Phi 15 \times 95\text{mm}$

807.036 electric motor core  
(MAX motor-Switzerland)

807.037 electric motor cable

807.025 electric motors handle

Power cord

807.024 controller(LCD display)

Sterilization Case



110F.032 for lap instrument  
525×300×155mm

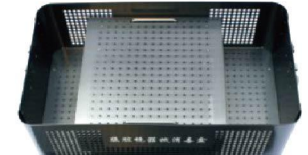
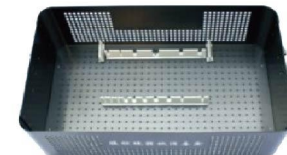

110F.033 for Electric morcellator  
540×250×135mm

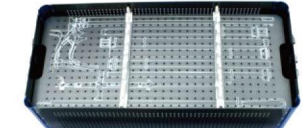

110F.030 for surgery instruments  
540×230×70mm



110F.031 for surgery instruments  
550×250×100mm



110F.041 for sinuscope  
270×84×42mm



110F.034 for resectoscope  
430×280×90mm

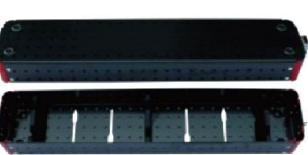

110F.040 for laparoscope  
425×84×42mm

Medical Equipment



JRL-II LED light source (high luminosity)



JRQ-1 CO2 insufflator



JRG-(A) Irrigation Pump



815.021 Laparoscopic simulator



815.004 light cable Φ4×1800mm



816.003 Endoscopy pump (medical pressurizer)



Flushing pump (instrument cleaning machine)

Medical Equipment

ICCD Endoscopy Tower/Rack



display 17"、19" LCD

- DVD burner
- Endoscopic interface
- DVD burner
- Computer host Fangzheng or Lenovo
- Printer Hp6000 color spray
- Foot switch
- High-grade aluminum alloy
- multifunctional trolley
- Laparoscope special software

3CCD Endoscopy Tower/Rack



display 17"、19" LCD

- DVD burner
- Endoscopic interface
- DVD burner
- Computer host Fangzheng or Lenovo
- Printer Hp6000 color spray
- Foot switch
- High-grade aluminum alloy
- multifunctional trolley
- Laparoscope special software

Digital high definition image workstation  
display 22" LCD

- DVD burner
- Endoscopic interface
- DVD burner
- Computer host DELLI5-2400
- Printer Hp6000 color spray
- Foot switch
- High-grade aluminum alloy multifunctional trolley
- Laparoscope special software



815.010 Camera



### GQ-IV Hysteroscope

J6235 Hysteroscope 22°C  
Φ6.4×178mm



J4235 Hysteroscope 22°C  
Φ4.4×178mm



### GQ-V Hysteroscope



T3313 Endoscope Φ4×310mm



W4035 Working element Φ4.8×216mm



W4024 Outer sheath&Obturator F24×178mm



### GQ-VA Hysteroscope

J3313 Endoscope 30°C Φ4.4×310mm  
W4035 Inner sheath F20×250mm (F6 obturator)  
W4034 Outer sheath F24×240mm



### GQ-VB Hysteroscope

T6243 Endoscope 30°C Φ6.4×240mm  
P1801 Light Cable Φ4×1800mm  
T6240 Endoscope 0°C Φ6.4×240mm



### SL-III Hysteroscope For Inspection

T2263 Endoscope 30°C Φ3.2×210mm  
P1801 Light Cable Φ4×1800mm  
T6240 Endoscope 0°C Φ4.4×230mm



### GQ-II Hysteroscope For Inspection



T1293 Endoscope 30°C Φ3×290mm



W4112 Inner sheath F12×255mm



W4115 Outer sheath F15×240mm



W4110 Adapter (for W 4110)



DQH-II Hystero-Electrotome



N5211 resectoscope (active/optional)

T3315 Endoscope 25°C Φ4×310mm

